

Article number: 204150M840D3SK  
 Description: E+G levelling foot  
 GN 41-50-M8-40-D3-SK  
 Note: SK With nut, External hexagon at the bottom

## Measures

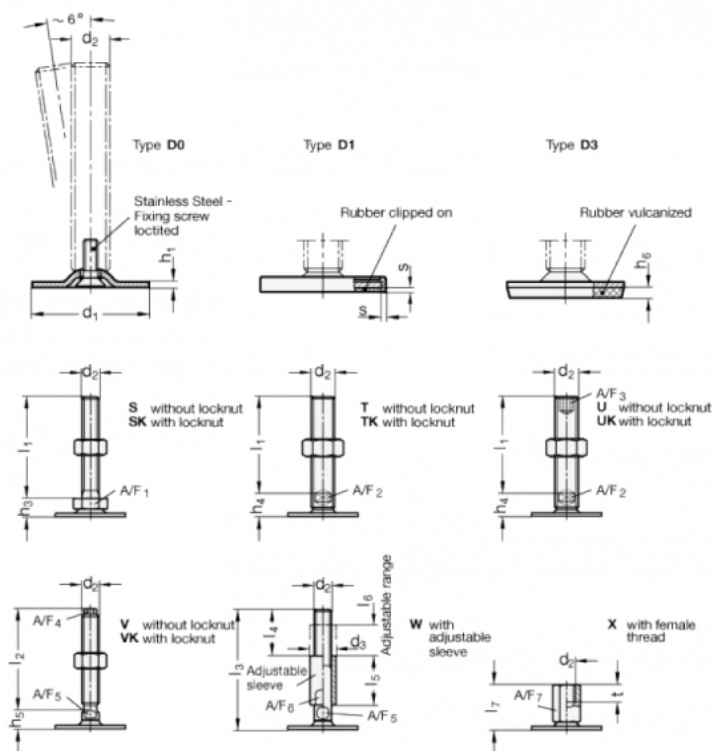

A/F1 = 17  
 d1 = 50  
 d2 = M8  
 h1 = 2.5  
 h3 = 11  
 h6 = 4  
 l1 = 40  
 s =